



# Considering Solar

A Detailed Guide - Part 1 | LG Solar



How to save on your electricity bills, help increase the value of your house and achieve better environmental outcomes by purchasing quality solar equipment.

Check out: [LGenergy.com.au](https://www.lgenergy.com.au) or call LG Solar direct on **1300 152 179**

# Contents

|   |    |
|---|----|
| Why Did I Write This Guide?                               | 3  |
| The Key Benefits Of Going Solar                           | 5  |
| Six Tips to a Great Solar System                          | 7  |
| How Solar Works   | 11 |
| Solar: The Financial Realities                            | 13 |
| Solar Panel Installations Explained                       | 15 |
| The Origin of Your Solar Panels                           | 18 |
| Installing Quality Panels for Great Long Term Performance | 19 |
| The LG Installation Partner Network                       | 21 |
| Mounting Systems  | 23 |
| Contact Details   | 24 |

There is also a Part 2 of this guide which can be obtained via [LGenergy.com.au](https://www.lgenergy.com.au)

|   |    |
|---|----|
| <i>What This Guide Will Offer</i>                                   | 3  |
| <i>The Inverter Solution</i>  | 4  |
| <i>Solution for Roofs That Have Some Shadow</i>                     | 6  |
| <i>Solar Panel Technology An Overview</i>                           | 7  |
| <i>Check on the Component Manufacturer</i>                          | 8  |
| <i>Metering Option for Your Solar System</i>                        | 9  |
| <i>Solar and Batteries</i>  | 10 |
| <i>Important Information You Should Know About Solar Warranties</i> | 11 |
| <i>The 5 Steps to a Quality Solar System Installation</i>           | 13 |
| <i>Solar System - Long Term Maintenance</i>                         | 14 |
| <i>Solar Summary</i>  | 15 |
| <i>Solar Industry Overview</i>                                      | 19 |

# Why Did I Write This Guide?

Solar power looks straight-forward, some panels, any panels plus an inverter. What could go wrong? Unfortunately there are many pitfalls in solar.

My name is Markus Lambert and I have been in the solar industry since 2006. I used to work in politics. I left that career, as I felt there were too many “high promise - low delivery” characters. Unfortunately today some aspects of the solar industry in Australia today are worse.

Over-supply from China has forced many quality German, Australian and Japanese panel manufacturers out of the market. There were over 300 Chinese manufacturers delivering millions of panels into the Australian market between 2010 and 2020, but many have now left, some have gone bankrupt and their warranties are worthless.

When the rebate in the insulation industry was shut down, some operators moved into solar, lured by the solar rebates. Unfortunately the solar industry was over-run by cheap product dressed up as quality. Buyers often didn't get what they expected.

When cheap product prematurely fails and customers on-mass seek to exercise their warranties, one strategy is for the installation company to dissolve or phoenix and the customer sits with no support, a failed system and compromised financial return.

Since 2011 according to the records from ASIC liquidated company register, close to 750 solar installation companies have left the industry - often to avoid warranty obligations. One in three solar systems has either the solar equipment manufacturer or the



installation company no longer trading and is therefore not supported, despite what looked like strong and lengthy warranties. These are the solar realities of today.



## BUYERS TIP

1. Close to 750 solar installation companies\* and more than 300 solar panel manufacturers have left the industry, leaving one in three residential solar systems without adequate support.
2. The LG 25 year product replacement warranty, together with the expertly trained LG dealer network offers a clear and stable alternative.

\* ASIC register

These unsupported systems are known as “zombie solar”, “orphaned solar” and eventually landfill solar.

I recommend the next time you see an unbelievable bargain price for solar with a “25 year performance warranty” (virtually unclaimable) and “Tier 1 panels” (meaningless as any indication of quality) do your research into the company and product on offer, as often it’s too good to be true.

True Value Solar, Euro Solar, Solar Shop, Energy Matters, Beyond Building, Eco Kinetics - all offered very appealing solar specials and were big national operators. Now they are all gone and their customers are stuck.

When these solar systems break-down generally the best advice is, “let’s start again as the warranty has run out, the product support is non-existent, the installation is of poor quality and expensive rework is required”. The old buyer’s rule applies in solar – “Buy cheap, buy twice”.

From an environmental perspective failed cheap systems are unlikely to have mitigated climate change, as the embedded energy required to make the solar equipment in the first instance has in many cases not been recovered by cheap solar before its failure.

Rebates on solar systems, called “STC’s” are paid for by power companies and indirectly by us, power customers. As cheap solar receives the same rebate as quality equipment, ironically we all

pay more for our grid electricity because of failed cheap solar and society receives no benefit in lower CO<sub>2</sub> pollution. The rebate scheme was designed to do exactly the opposite.

The best way we can achieve solar’s potential to remove CO<sub>2</sub> emissions and generate a great financial outcome is to buy a quality solar system, installed by a strong quality focused installation company, offering long term maintenance and support. In that case solar is a great idea.

Happy reading.



**Markus Lambert**

General Manager LG Electronics - Solar Division



## BUYERS TIP

3. The buyer’s rule applies in solar – “Buy cheap, buy twice”.

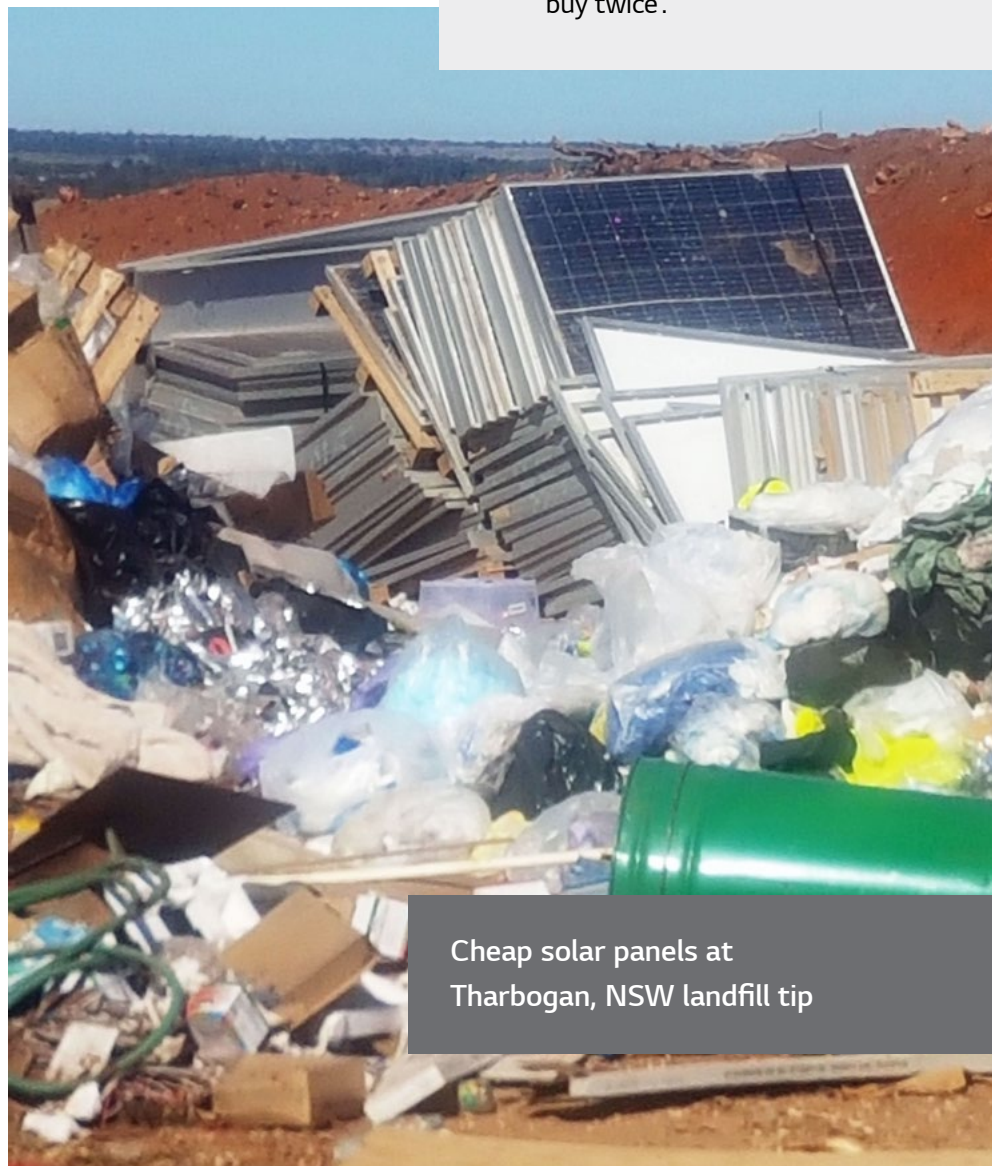

Cheap solar panels at Tharbogon, NSW landfill tip

# The Key Benefits of Going Solar

## 1. SAVING MONEY

Installing solar power enables you to generate your own electricity. By using your own electricity rather than buying it from your electricity company, you will save money as every kWh of electricity you use from your solar system is a kWh of electricity you do not have to buy.

While cheap budget systems have been removed after as little as 3 to 4 years, quality systems can last more than 25 years. So if you have recouped the installation cost after 5 years, as long as the system inverter continues to operate, the 25 year product replacement warranty with LG panels means you are very likely to continue making significant savings for more than 20 years after all your initial system costs have been covered.

In many cases with an LG 6.6kw system this can represent a \$40,000\* saving in electricity cost over 25 years, if you self-consume approx. 60% of the system generation. The annual return on investment after the system has been paid off in these circumstances is regularly 20% plus, as the annual saving can be around \$1,700 for the initial \$8,500 investment.

## 2. ENERGY INDEPENDENCE

Solar reduces your reliance on the electricity grid and electricity retailers etc. If you add batteries to your system in the future, then even if there is a blackout your necessities such as the fridge, washing machine and lights do not have to stop.



## BUYERS TIP

4. High quality LG solar panels can add value to your home, due to the stable and strong 25 year product replacement warranty.
5. An independent study by [realestate.com.au](https://www.realestate.com.au) in 2015 came to the conclusion that installing a quality residential solar system can increase the value of your home.

\* Based on an annual saving of \$1,600 for a 6.6 kw system with 60% self consumption at 27c per kWh and 40 % FIT and a FIT of 11c per kWh in Sydney.



1 in 4 suitable Australian homes have solar panels - like here in Darwin and 1 in 3 solar systems is a “zombie system” where neither installation company or product manufacturer is still in business in Australia.

### 3. ENVIRONMENTAL BENEFITS

By using renewable energy sources, we reduce the need to generate electricity from fossil fuels like coal and gas which create carbon dioxide (CO<sub>2</sub>). More use of renewable energy can reduce the impact of global warming. This effect is even stronger if your solar system lasts a long time.

### 4. PROPERTY VALUE

There is an Australian study that has found that installing a quality residential solar system can

increase the value of your home. Home buyers are increasingly recognising that a home with quality brand solar panels installed will have lower electricity costs.

[realestate.com.au/news/85-of-aussies-say-solar-panels-boost-property-prices](https://realestate.com.au/news/85-of-aussies-say-solar-panels-boost-property-prices)

The LG 25 year product replacement warranty is transferable to any new house owners and is a strong house asset when it comes to selling.

If you chose branded high quality panels like LG, then for example after 10 years, you can sell the house and have quality solar as an added value selling point together with other advantages that make your home attractive, such as additional parking spaces, a outdoor pool or beautiful views. The remaining “15 years transferable LG solar panel product replacement warranty” is clearly a strong selling point - as there is a warranted future electricity saving linked to the house.

# Six Tips to a Great Solar System

Few electric products last as long as LG Solar panels. With an operational life of 25+ years it makes sense to spend a little time on this investment to ensure you achieve the best possible outcome for both the environment and your finances. The good news is that in selecting LG panels you are half way to getting a high performance solar system.

## 1. CHECK YOUR ROOF

There is a daunting choice of solar panels and inverters available today but considering available roof space and shading is a good first step to narrowing down the best solar system for you.

The roof is where your solar dreams meet head-on with the reality of what is possible. Make a note of any shading on the roof from growing trees, street lamps or power poles, power lines, aerials, chimneys and neighbouring buildings. Shade is the enemy of solar power but micro inverters, power optimisers and high efficiency panels will mitigate these losses. If you have no shading a single quality “string inverter” is generally the best financial option.

Solar panels are best installed on north, west and east roofs so assess the space you have in these directions. An average family household today uses 15-25kWh a day. This requires space for 12-25 panels (3.5-6.6kW) with the likelihood of smart homes, electric cars and solar batteries in the future, the PV system size most likely need to increase. Unless you have huge areas of good roof available it is advisable not to limit your solar future by clogging it up with low efficiency panels. We recommend installing panels with a capacity of 350W or more.



LG NeON<sup>®</sup> 2 and NeON<sup>®</sup> R panels produce solid performance outputs in all weather conditions

If tiles are weak, old and cracked, tin is rusty or the roof is 'sagging' it is advisable to address these problems before solar panels are installed. The usable life of LG panels is 25+ years so proactively making repairs on roofs can save headaches once solar panels are installed.

## 2. GATHER INFORMATION

Understand the feed-in tariffs your local electricity retailers are offering for excess electricity exported back to the grid. In most cases this skews the financial considerations favourably towards getting the biggest system the grid provider will allow.

A bigger system with a well-paid feed in tariff will generally minimise the purchase of expensive grid electricity and maximise income

from power sold back to the grid. Expanding a system at a later date is possible, but substantially more expensive than getting the big system upfront due to paying installation cost twice and the annually reducing value of rebate.

East facing solar panels start generating power from sunrise, north facing panels generate more power in total and west facing panels keep generating until sunset. A west orientation is generally good as it supports air conditioning loads in the afternoon.

Rarely are roofs so perfect that they have space in all the directions you would like to have panels. However, it's useful to understand your household time-of-day power use to make the most of your roof and intelligently locate panels to

generate free power when you need it most. For homes that use most power when the sun goes down and who easily cannot load-shift power to daylight hours the best solution may involve solar with a battery to store the power.

## 3. RESEARCH SOLAR PANELS

Visually panel brands look similar but there are huge differences in performance, design, build quality, componentry and the life expectancy of panels. The key consideration in selecting panels is not the upfront cost, but how long they will last as this has the biggest impact on the total solar power generated and the savings made. A quality solar system can save many tens of thousands of dollars over its life compared to a budget brand package.

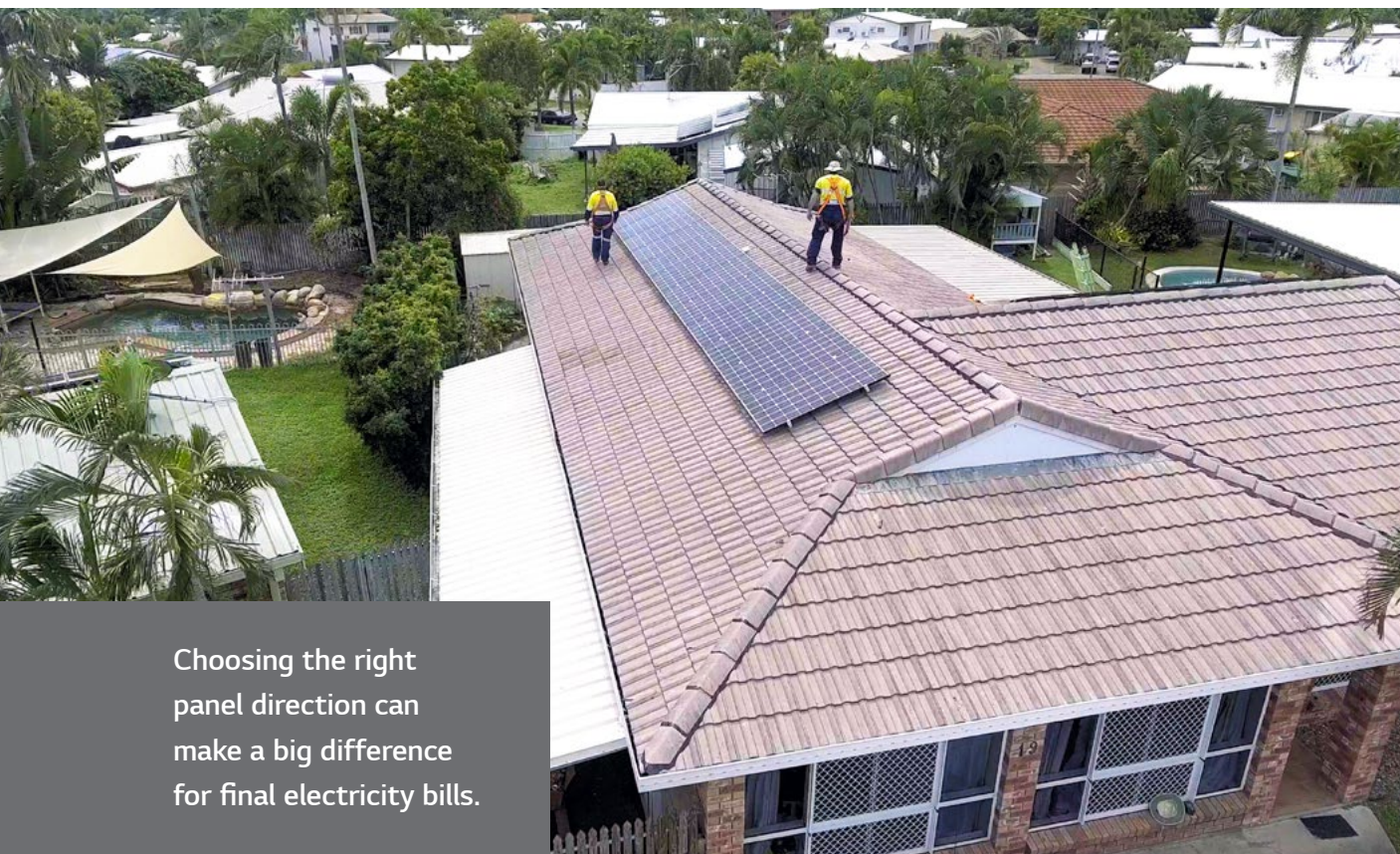

Choosing the right panel direction can make a big difference for final electricity bills.



Cheaper budget brands in the harsh Australian climate have failed in as little as 3-4 years and many inside 8-12 years. So while the price of cheap panels price budget is appealing you may well have to buy 2 to 3 times compared to once for LG.

Retain a healthy scepticism of “too good to be true” stories because the cheapest is not the best. Some budget system solar installers have only got their own profit interests at heart, not yours and want to sell what they have in the shed - not what you need.

#### 4. FIND A QUALITY FOCUSED LOCAL INSTALLER

Research reputable local solar companies; avoid door-to-door salespeople and those that use ‘high-pressure’ tactics and lots of internet spruiking with low ball prices. A company that has a long trading history is considerably less risky than a new start-up.

Membership of an industry body such as the Clean Energy Council (CEC) or Smart Energy Council membership is something that both good and bad installers possess. It is often a mandatory requirement to operate in the industry and is not a strong indication of quality, professionalism or integrity.

Obtain installation quotes from a few companies to compare equipment and costs. A good solar company will be looking for information on your roof and household power usage. They will tend to ask questions, understand your needs and consider your roof/shading in detail before offering solar packages.

Good solar companies will tell you about challenging shading, roof-space or wiring issues. All installers offer installation warranties but remember these are only of value if the company stays in business over the long term. Sadly this is not always the case in solar and many warranties are now worthless. So ask how long your installation company has been operating. Less than 5 years means they are still cutting their teeth.

The members of the LG Solar Authorised Dealer group have often been in solar for a decade and are considered some of the best in the industry. They would be a good starting point to get a great install.

#### 5. CHOOSE YOUR SOLAR PANELS AND INVERTER SOLUTION

You may not intend to stay in your house for 25+ years but purchasing a recognised brand of quality panels like LG, with a comprehensive 25-year transferable warranty, will likely add value to your property, be a feature when selling, give you and future owners long-term security, peace of mind and not least deliver many tens of thousands of dollars-worth of power savings over 25 years.



#### BUYERS TIP

6. The key consideration in selecting panels is not the upfront cost, but how long they will last.

Cheap panels fail early, are more likely false economy and while the joy of the cheap price is soon forgotten it may well be replaced by years of regret and a poor environmental outcome when they go into landfill.

Look for efficient, durable solar panels from a company you already know and trust. LG NeON<sup>®</sup> 2 solar panels with Cello Technology have a double-sided solar cell structure, enabling them to capture light and generate energy from both the front and back. When the angle of light is lower during mornings and evenings, times homeowners are most likely to be home, LG NeON<sup>®</sup> 2 solar panels will generate more energy than others that only capture light from the front.

These solar panels provide great value for budget-conscious customers and are backed by an industry leading 25-year product and performance warranty. High-quality solar panels like these are low maintenance and have a very low failure rate.

LG panels work well with string inverters from SMA and Fronius and also Enphase micro-inverters and Solar Edge optimiser solutions. Tigo optimisers can help string inverters to handle shading issues.

#### **6. BUY WITH CONFIDENCE**

Purchasing a quality solar power system is one of the best practical decisions you can make both financially and for the planet.

There is no rush, but the sooner you get solar the sooner the power bill will fall. When the installation

is complete have the technician explain the monitoring system. When you understand the pattern of free solar power you can actively try to match household power usage to it by 'load shifting' appliances into daylight hours e.g. washing machines, dishwashers, clothes dryers, electric hot water systems, air conditioning and pool pumps. Having chosen an installation company and solar products that are high quality from a brand you trust, you maximise your chances of having a great solar system experience. Then all you need to do is let the sun love your home.

For more information or to calculate your savings via our ROI calculator go to [LGenergy.com.au](https://www.lgenergy.com.au) where we have answered over 300 solar questions in the FAQ section.



# How Solar Works

A solar system is made up of multiple solar photovoltaic (PV) panels, a DC to AC inverter and a framing system to hold the PV panels in place as well as cabling and isolators/switches.

Solar panels are generally fitted on the roof facing a northerly, easterly or westerly direction. The direction

the panels point affects the hours they will produce most electricity. For example panels pointing west can, if they are quality panels support the air-conditioning needs on a hot afternoon very well. Cheaper panels tend to perform poorly the hotter it gets when compared to LG NeON® panels.

Most homes in Australia and NZ are connected to the electricity grid via power lines (the grid). Our electricity system uses 240V alternating current (AC), but the electricity generated by solar panels consists of direct current (DC). This means the DC electricity needs to be converted to AC electricity via the inverter.

## GRID CONNECTED HOME WITHOUT BATTERIES

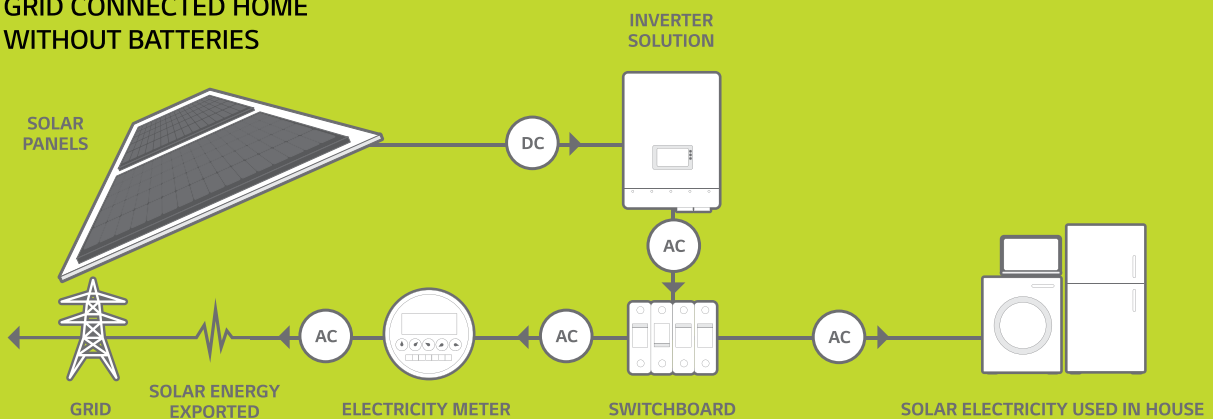

## GRID CONNECTED HOME WITH BATTERIES

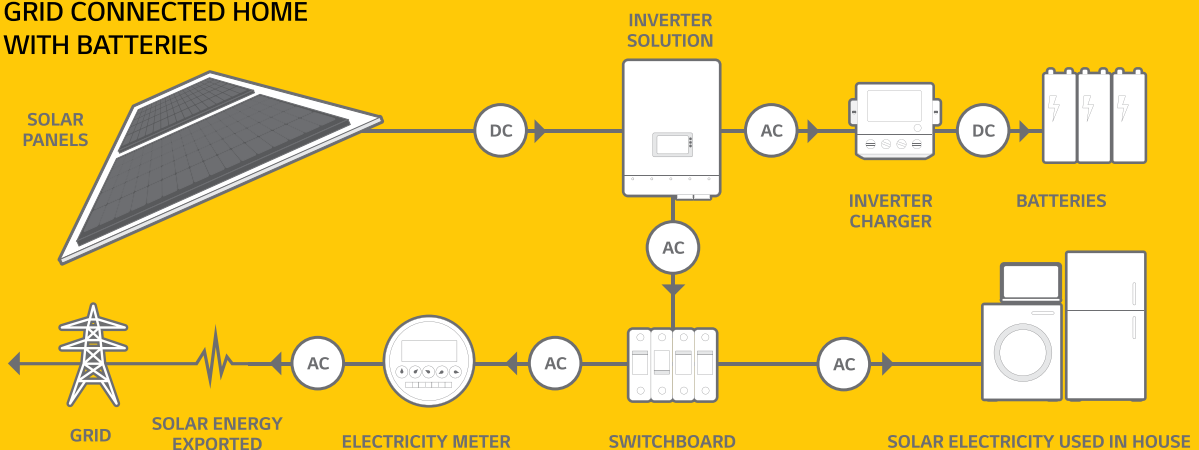

The electricity that is generated by the solar power system will be consumed by the appliances in the house first and then the excess electricity will be exported to the grid and in many cases the homeowner is paid for this excess electricity. These payments are known as a Feed in Tariff (FIT).

Unless you add storage batteries to your system, a grid-connected solar system is unable to store power in your home for use at night. For safety reasons the solar system without a battery will also turn off when the grid is down (via a blackout), as lines person repairing electricity wires could be endangered if solar panel system electricity is feeding back into the powerlines during the blackout.

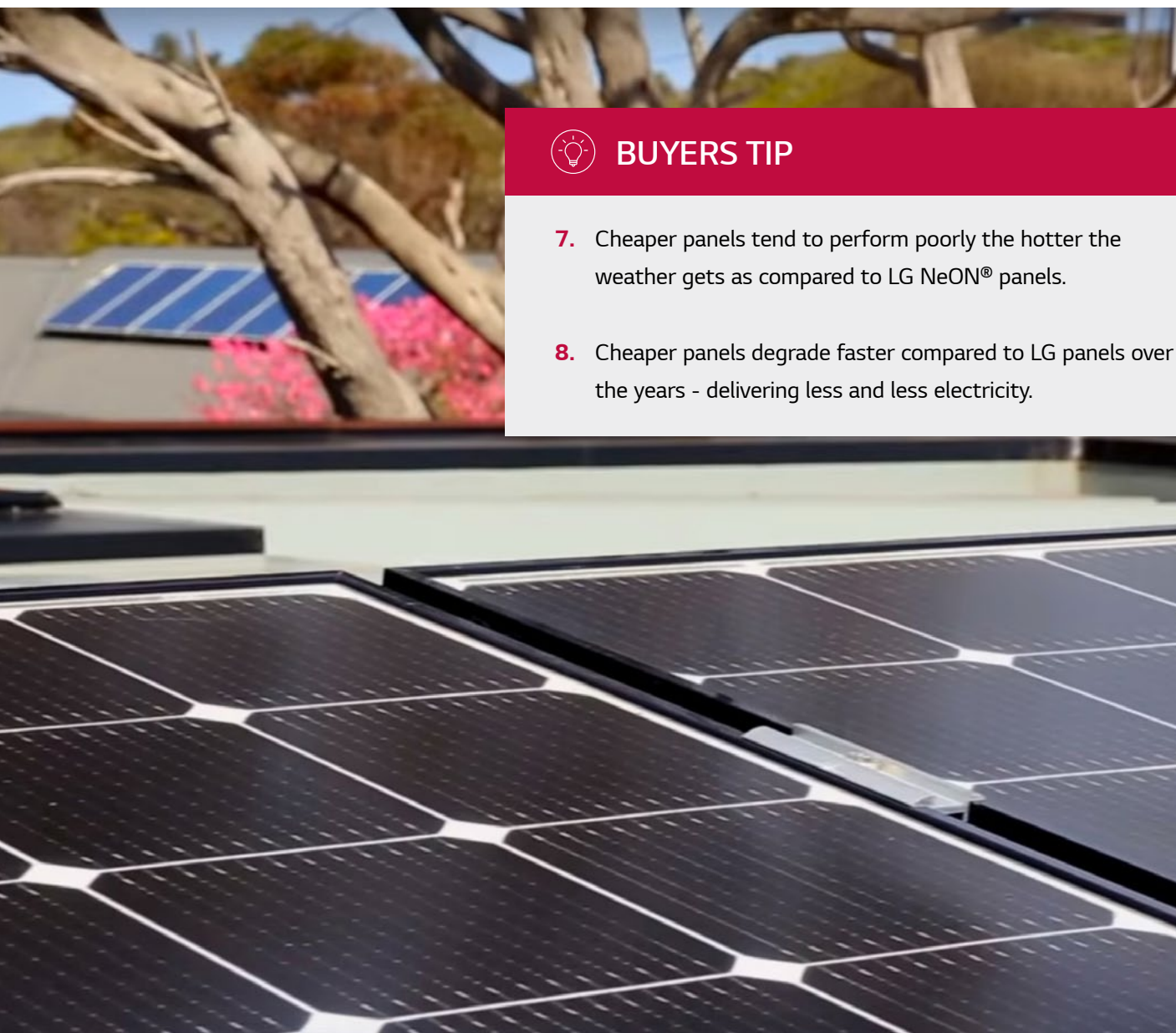

## BUYERS TIP

7. Cheaper panels tend to perform poorly the hotter the weather gets as compared to LG NeON® panels.
8. Cheaper panels degrade faster compared to LG panels over the years - delivering less and less electricity.

# Solar: The Financial Realities

## SOLAR REBATES - WHAT IS AVAILABLE FOR YOU?

Rebates may be available for your solar system, and can be claimed by most house owners. A 6.6 kW system in 2020 attracts around a \$2,800 to \$3,000 in Federal rebate called Small Scale Technology Certificates (STCs), but it does vary in different regions and STCs only get paid for a system up to 100kW. Some states like Victoria also offer state based support programs. Over the years these rebates have changed and may continue to change in the future.

Talking to your nearest LG Authorised Partner will give you updated information about the latest rebates applicable to you. When you see advertised sales prices for solar systems, these prices usually have subtracted the rebate from the full price. The rebate will reduce every year in January, for the next few years.

## THE FEED-IN TARIFF EXPLAINED

Feed-in tariff's (FIT's) are not a rebate - but are a defined payment for the electricity you generate from your solar system that is sent back to the grid, when you are not using it at the time it is generated. Currently energy retailers in many States pay a FIT ranging from 7 cents in WA to 12 and even 20 cents in other states. These FIT rates are based on state guidelines and vary between electricity retailers. We recommend shopping around between retailers to determine the best available FIT rate for you.

Some Energy Retailers sell solar systems and will tempt you with a high FIT. Please check that the overall electricity charges in such contracts are not higher than normal kWh charges, as your higher FIT income may be more than offset in higher electricity fees and charges.

The value of a FIT is an important aspect to consider as it can influence the economic outcome of owning a solar system and what the ideal size of a system should be in your individual case. Good solar installation companies, such as LG Authorised Partners as part of their site visit should offer a detailed analysis of what they expect your self-consumption to export ratio to be, and what economic outcome you will be able to achieve. They also should be able to point you into the direction of the best local FIT deal available.

Naturally if you install batteries with your solar system the FIT is less relevant, as your battery will absorb the unused electricity first - before you export to the grid.



## BUYERS TIP

9. Shop around for the best feed in tariff and consider all charges in such contracts, including the cost of the supplied electricity per kWh and the supply fee to get the true picture.

### TYPICAL PAYBACK PERIOD FOR A SOLAR POWER SYSTEM

A well-designed quality solar system has a typical payback period of around 4-7 years in Australia. The period can vary depending on your electricity usage and your system size, but when you get quotes for solar power systems, the LG partner installer should do a financial analysis to estimate your payback period.

### FINANCING A SOLAR SYSTEM

Many Australian and New Zealand customers buy solar power systems with cash. If you are debt-free and have some spare capital then investing in a solar power system is a good idea. A solar system installation where appropriate typically generates reliable returns that at the time of writing are far higher than bank interest rates.

Your LG partner installer will advise you whether a solar system is suitable for your site.

However not all of us have the luxury of easy access to thousands of dollars. A lot of solar installers offer “no interest” finance – and if that sounds too good to be true, it’s because it probably is.

In our experience you can often get a better deal by organising your finance independently and avoiding the easy-sign-up, ‘no interest’ deals. For example, many homeowners can redraw their mortgage to finance the solar and battery system, as these loans have currently very low interest.

Local credit unions also sometimes offer green loans or the installer works with finance companies to offer loan options. Consumers also have the option to finance a solar system. The LG installation partners can give solid advice.



## BUYERS TIP

10. If you see a deal that claims ‘no interest’ your “be careful” detector should be going off. All finance has a cost – the “no interest” deals often charge the installer a fee on top of the cash price - upfront. That cost is passed on to you.

# Solar Panel Installations Explained

## Site inspections can help to work out where your panels should go

An LG Authorised Energy Partner in many cases will visit your home for a site inspection. This would probably include checking the roof position, discussing your electricity usage pattern, monitoring options. Where applicable your LG Authorised Solar Partner will conduct a shade analysis to ensure that the right quantity of the most suitable panels are placed in the optimum position.

Buyers should insist that their installation company undertake a physical site inspection. An installer's willingness to visit your

home gives some indication as to the quality of service you will receive. As a result we advise that you buy your solar system from a reputable local company and not an internet-based solar sales agent.

Since 2010, internet solar sales companies often sell solar systems without site inspections and only look at satellite images of roofs. Sometimes this results in the installer, on the installation day highlighting the need for special roof brackets or a total switchboard upgrade before the solar system can be installed. These additions add unexpected costs and time delays to the installation. So if possible, ask for a site inspection.

## HOW MANY PANELS DOES MY SYSTEM NEED?

Currently a popular size is around 6.6kW of panels with a 5 kW inverter. The reason is that in many areas this size is the biggest the energy retailers will allow the customer to connect.

The biggest regret I hear from time to time from solar system owners is that they did not allow for the variations in output over the year - therefore the lower production in winter, means that maybe a bigger system would have been a better idea.



Site inspections are important to establish the most appropriate panel position for your specific electricity usage pattern.



## BUYERS TIP

### 11. Buying panels with confidence from a solar panel manufacturer

- Visit the panel manufacturer's website - is it a local Australian or generic worldwide site? An extensive local site may demonstrate their local commitment;
- Make sure they list an Australian office with an office number you can call easily;
- Make sure the warranty claim process is clearly outlined on their website;
- If they highlight the performance warranty as something special - see this as a warning light - as this warranty is in reality very weak;
- Generally speaking dealing with a reputable well known solar panel brand will ensure that you are receiving a meaningful warranty.

### WHY PANEL EFFICIENCY MATTERS

A few years ago many buyers of residential solar did not consider the efficiency of their panels. If they wanted a 5kW system they could buy 20 panels with 250W or 23 less efficient 220W panels. Most customers could never have imagined in the future they would need more than 5kW of solar. That was the old solar thinking.

With the emergence of battery storage as a smart way to harvest the light during the day and then to use this electricity at night, panel efficiency has become an important consideration. Considering the future prospect of electric cars is coming fast with many makers announcing future electric car models; you might want to expand your solar system in the future to create electricity to power your electric car.

Worldwide CO<sub>2</sub> emission reduction could be enormous if we are able



Higher efficient panels can help to keep batteries charged for longer and are more suitable for future proof solar systems

to utilise our roofs to generate more of the fuel for our vehicles. In short in the future one might want a 5kW solar system for day use and 2kW of solar for the batteries to use at night. Charging the car would require another 4-8kW of

solar. So in short - higher efficient panels will be more useful in the future as these panels either allow you to install a bigger system NOW or save roof space now for future system expansion.



**WHY WOULD I NEED THE 25 YEAR LG PANEL PRODUCT WARRANTY - IF I SELL MY HOUSE AFTER 10 YEARS?**

With an approx. \$1700 average annual saving in electricity cost from a quality 6.6kW system\*, after 10 years owning a LG panel system - you would save over \$17,000 in electricity bills, and around \$9,000 in clear savings.

If you now sell the house after year 10, the new owner can take advantage of the LG transferable product replacement warranty with 15 years warranty remaining. This will allow the new owner, if his/her electricity consumption patterns are similar - an approx. \$25,000 electricity cost saving in those 15 future years (as long as the inverter is kept running based on prevailing electricity prices and FITs).

A skilled real estate agent will highlight how the LG brand panel system will add financial benefit in the same way as other home options, such as high-end kitchen appliances, ducted air-conditioning, gas heating or a swimming pool. It's as one of the LG installation partners tends to say from a financial aspect a bit like: "Having an Airbnb room in the house - permanently rented". On the other hand with many unknown solar panel brands on the house - the new home buyer might ask - "is this system safe?"

**WHAT IS THE BEST AND DIRECTION FOR PANELS?**

The sun rises in the east and sets in the west. This means that east-facing solar panels will produce most of their energy in

the morning. North-facing solar panels will peak around midday (and provide the most energy overall) and west-facing panels will produce very little in the morning and generate most of their energy in the afternoon.

It used to be true in 2006 or even 2008 when a single panel cost over \$1000 each, that if you couldn't put panels on a north-facing roof, then a solar power system wasn't worth it. Now that prices of solar power systems have dropped so much (around 80% over the last 7 years in Australia), to have, any combination of east, west and north facing panels can be economical. To a large degree the decision comes down to what time of day you use most of the electricity.

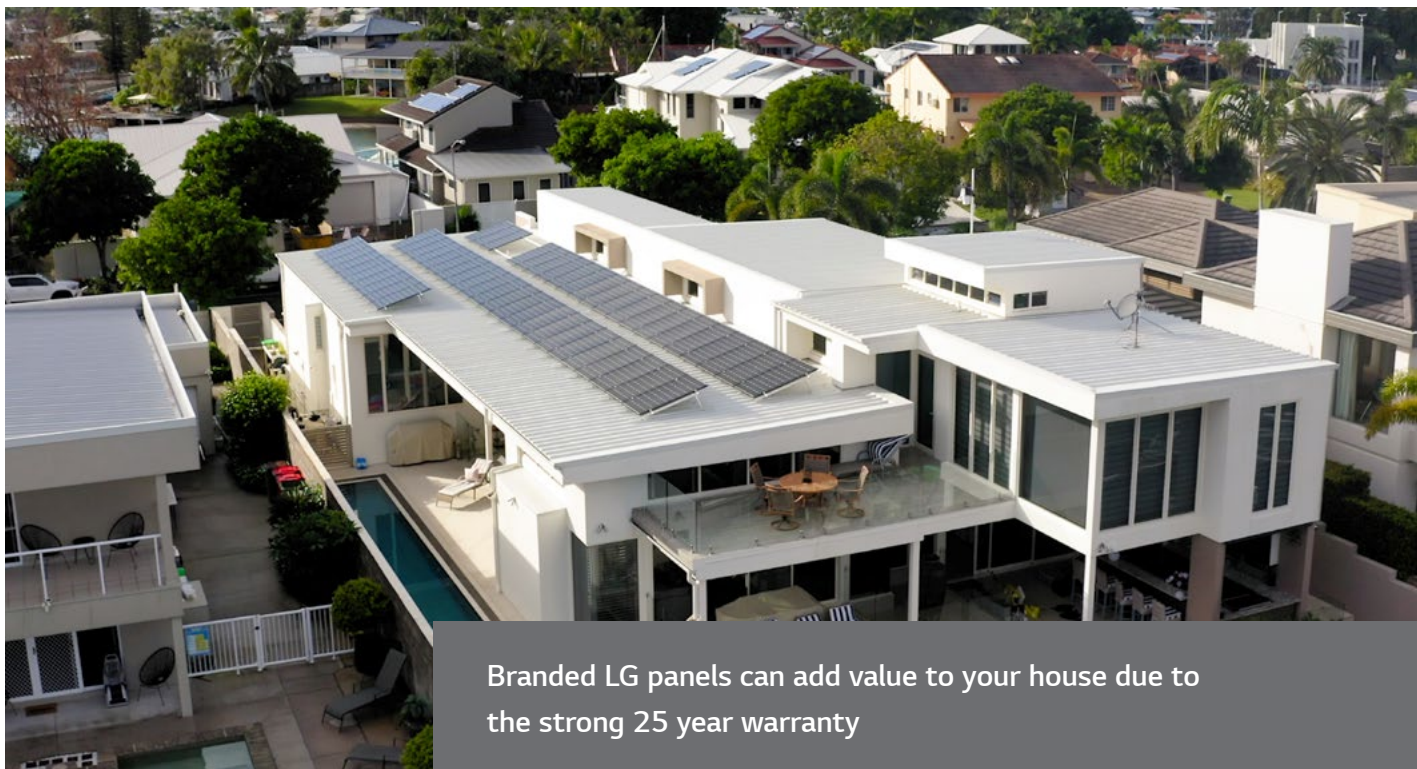

Branded LG panels can add value to your house due to the strong 25 year warranty

\* In Sydney at today's electricity rates and a 40% of generation exported at a feed in tariff (FIT) of 11 cents kWh.

# The Origin of Your Solar Panels

Where are my panels from? Which country do I support by buying which type of panel?

China has reached a strong dominance in renewables with many German manufacturers leaving the field. Only a few manufacturers are making panels without considerable Chinese influence.

The following panel manufacturers either have got their headquarters in China, are owned by China or make some of their panels in China.

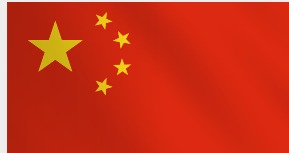

## China

BYD  
Canadian Solar  
CSUN  
ET  
GCL  
Hanwha Q Cells\*

JA Solar  
Jinko Solar  
German Solar  
LONGi  
REC (Ownership China)\*\*  
SunPower\*\*\*  
Suntech  
Talesun  
Trina Solar  
Yingli Solar  
Seraphim

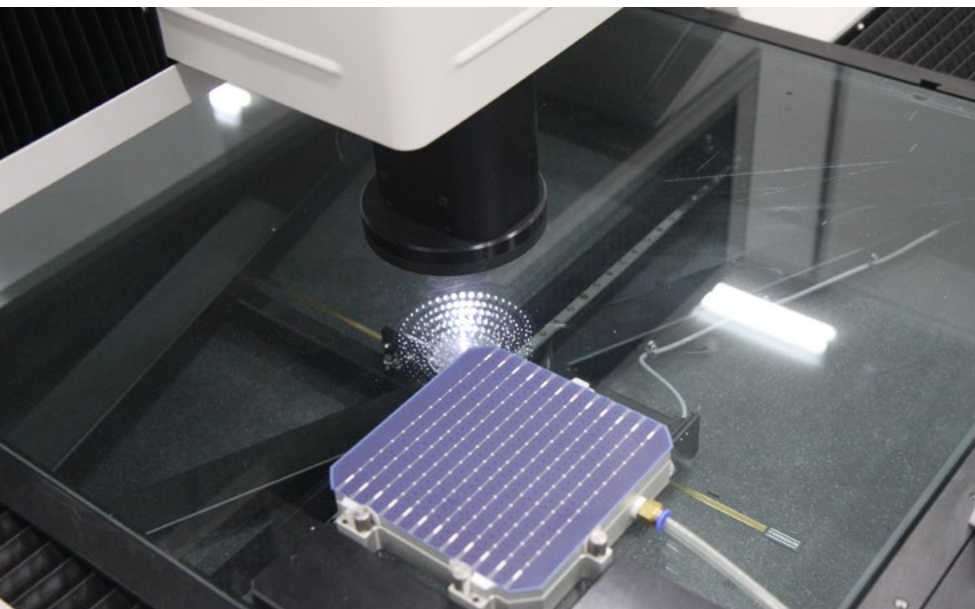

The LG solar factory in Gumi, Korea enjoys a very high level of quality control

Manufacturers with product manufactured in other countries:



## Vietnam

Hyundai Heavy Industries\*\*\*\*



## South Korea

LG Electronics

\* Also manufactures some models in Korea

\*\* Panels manufactured in Singapore

\*\*\* Also manufactures some panels in Mexico

\*\*\*\* Not part of the Hyundai Car Company. Head office in Korea.

# Installing Quality Panels for Great Long Term Performance

LG is confident that our panels will give you years of reliable service. As of February 2020 less than 100 panels have been replaced due to manufacturer related issues - from over 1.2 million LG panels installed across Australia and New Zealand since 2010.

Although cables, safety devices and mounting systems are less influential to the performance of your solar system, choosing cheap poor quality cables or isolators, can lead to premature system failures. In cases where non-branded plugs and cables were used, complete system failures have occurred, including house fires.

## WHY TO CONSIDER LG PANELS

### 1. Top solar product warranty available

LG NeON<sup>®</sup> 2 panels come with a 25-year product warranty (parts and labour), 15 years longer than many other panels, and also a 25-year performance warranty. This warranty is backed by a diversified electronic company, LG. You can trust LG to have your back from install to product support.

### 2. Strong brand

The largest consumer brand in solar in Australia;

### 3. High wind resistance

Higher wind resistance than many competitor panels;

### 4. Locally backed entity

Australian legal entity backed by a dedicated local solar team;

### 5. Award winning technology

You can rely on these panels to offer you one of best technologies. LG's solar panel range have won multiple International Awards and the Top Brand award in Australia 4 years in a row (2016-2019)

### 6. Robust standard

Stronger salt mist corrosion protection than many competitor panels;

### 7. Warranty stock available locally

Compatible warranty panel stock still available locally in NSW warehouse, for every model sold since 2010\*;

### 8. Automated factory drives consistency

Made in automated factory in Gumi, South Korea to high precision specifications;

### 9. More Power per square metre

LG NeON<sup>®</sup> 2's 355W are



Compatible warranty panel stock still available locally in NSW warehouse, for every model sold since 2010

\* As at February 2020.

a similar physical size to many conventional 325W panels. This means with the LG NeON<sup>®</sup> 2 355W you get 9.2% more electricity per square metre than a 325W panel. Therefore you can install more kW of solar on your roof with the LG NeON<sup>®</sup> 2.



NeON<sup>®</sup> 2 - Full Black



NeON<sup>®</sup> 2 - Standard

**10. High performing panel**

One of the best performing panels in Australia when considering the combination of output, reliability, longevity and product support;

**11. Hot weather tolerance**

Better panel performance in hot weather than most competitor panels in Australia;

**12. Local helpline**

A dedicated LG solar customer helpline number- staffed in Australia ph: 1300 152 179;

**13. High performance for longer**

LG NeON<sup>®</sup> 2 panels have a lower degradation after year 1 and for each of the next 24 years than many competitor panels. Lower degradation over the life of the system also means comparatively more output in later years. Less production loss over 25 years for LG NeON<sup>®</sup> solar panels = more electricity for your home!

**14. Few warranty claims**

1.2 million panels sold in Australia and NZ as per Q1 2020 with less than 100 warranty claims;

**15. Diversified company**

Electronics manufacturer with USD 54 billion global income per annum (2018) and a long term commitment to solar.

**16. A great visual appearance**

LG NeON<sup>®</sup> 2 panels have been designed with appearance in mind. Their black cells, black frames and thinner wires give an aesthetically pleasing appearance. Your home deserves the LG NeON<sup>®</sup> 2.

**17. Efficiency delivered through innovative technology**

Award winning double sided cell Cello Technology and N-type silicon deliver more electricity per watt than most competitor panels;

**18. Warranty supported by strong financials**

One of the most financially strong, locally backed meaningful 25 year product replacement warranties on the market - true peace of mind.

**19. Take control with high-performance LG solar panels**

Enjoy multi award winning technology, better efficiency, higher power output and an incredible 25-year product and performance warranty when you take control with LG solar panels.

**20. Increase your savings**

More solar electricity means more energy bills savings! LG NeON<sup>®</sup> 2 better hot weather performance means LG will have less output loss than many other solar panels during hot summers.

# The LG Installation Partner Network

LG Solar has over 80 installation partners as part of the Australian-wide Authorised Solar Dealer Network. These solar installation companies have been vetted by LG and represent some of the best installers in the industry. They can provide free advice about solar, inspect premises and provide high quality installation service for solar systems and battery solutions.

If you do not want to use any of the LG partners, other qualified installers can also supply LG panels and purchase them from our distributors which can be found on

[LGenergy.com.au/lg-dealers/our-distributors](https://www.lgenergy.com.au/lg-dealers/our-distributors)

Nevertheless make sure the installer also uses quality inverter solutions and quality framing and isolators.

Sometimes you will find installers will push back on LG panels and claim “they are hard to get”, or “LG ran out of panels” or “they are too expensive and you just pay for the name”. In this instance - simply insist on LG panels and refer them to the list of wholesalers as listed on [LGenergy.com.au](https://www.lgenergy.com.au)

## HOW TO CHOOSE A QUALITY FOCUSED SOLAR COMPANY

It is recommended to use a reputable installation company that checks your specific solar system requirements. Please see the points below regarding the advantages of using a company, such as an Authorised LG installation partner promoting high quality products.

- A reputable solar retail company is more likely to fully evaluate your requirements and explain in detail what needs to be done in order to install your solar system.
- A local diversified company is more likely to be around in the future to service any warranty issues or system upgrades. With some loud, marketing and price focused solar companies longevity of the company can be an issue.
- If your installer is selling you LG solar panels, then in future years LG is very likely to be able to have a local company

## LG Solar Partner Training Day



service your LG panels. If you choose an unknown brand, the manufacturer may go out of business or the importer may stop importing these panels into Australia. It is recommended to buy branded solar panels from diversified manufacturers like LG that have a sound track record in Australia.

- A reputable solar company will be fully aware of current electricity supply rules as well as provide you advice on the best feed-in-tariff. As a result, well established businesses will be more likely to give you the most up-to date advice.
- If your local installer belongs to the Authorised LG Energy Partner network, then he/she has to install the solar power system to a high standard and act ethically in their business dealings with you, the customer.



## BUYERS TIP

**12.** The following are considerations when designing a solar system by an LG partner:

- Your current electricity consumption and future needs;
- The available roof space and optimum panel location;
- The orientation and pitch of the roof(s);
- Impact of shading across all seasons and time of day;
- The structural soundness of the roof;
- Sizing the strings of panels for the correct voltage of the inverter solution;
- Ensuring the design meets building codes and electrical standards;
- Determining the most suitable location for the inverter and the way the cables are run.

# Mounting Systems

Solar systems are mounted to roofs with a mounting system using rails and roof connection brackets known as "feet". Mounting systems are made of aluminium with stainless steel accessories. They are designed to accept a range of solar modules on a variety of roof types such as tin or tile. The solar panels are attached with clamps to the rail and connection brackets fix the rails to the roof.

There are similar mounting frames also for ground mount systems.

Purchasing a strong and well-engineered mounting system is the sensible way to protect the investment you have made in your solar system as they will be more rigid. Quality systems are usually more expensive as they use quality gear all around.

If a suitable roof area is not available, panels can be fitted to a ground-mounted system in a sun-filled spot. These options can be discussed with your local LG solar partner.



## BUYERS TIP

**13.** While the installation angle of the panels can influence solar output, overall a 5 to 10 per cent variance in installation angle only adds / subtracts a few percent of overall annual output, meaning it is not critical.

Panels flat on the roof eg a high-rise, while cheaper to install will need to be cleaned more often than panels installed at an angle. This is because rain helps wash dust off when the panel is at an angle.

Flat on the roof installs will minimise output in winter and give great results in summer as the sun is more overhead. Panels on a pitched roof will give relative better output in winter, than those installed flat on the roof, meaning pitched panels will give a more even result in performance over the year.

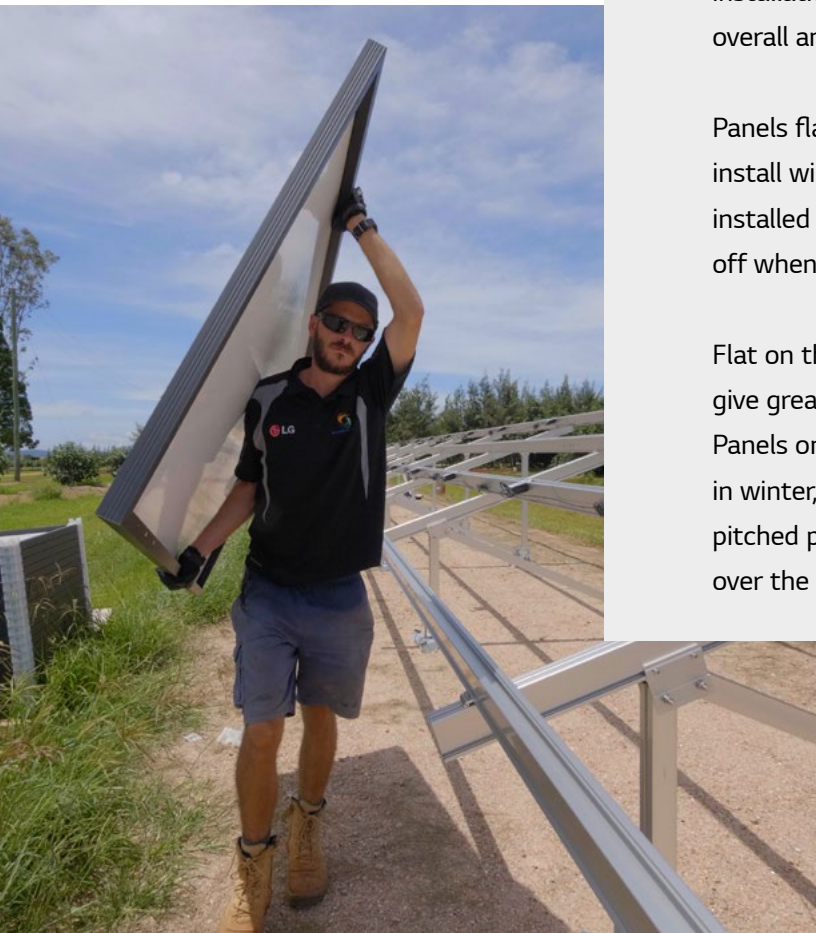



LG bifacial – see through panels

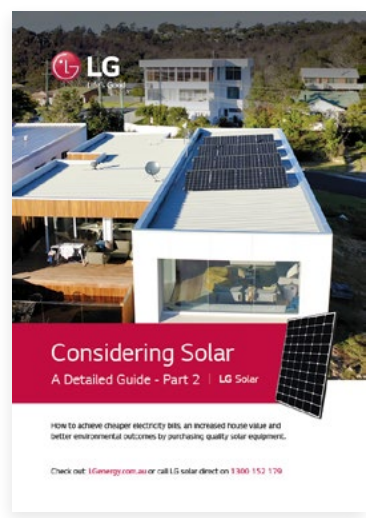

Now that you have read “Considering Solar - A Detailed Guide - Part 1” you might want to go to [LGenergy.com.au](http://LGenergy.com.au) to secure “Considering Solar - A Detailed Guide - Part 2”. The 2nd part explains about inverter solutions for your system, batteries - are they worth it, key warranty info and the importance of system maintenance.

A great guide to help you making an informed choice.

**HEAD OFFICE**

New South Wales  
2 Wonderland Drive, Eastern  
Creek, NSW 2766

**CONTACT**

Email: [solar.sales@lge.com.au](mailto:solar.sales@lge.com.au)  
Enquiries: 1300 152 179  
(Australia)  
[www.lgenergy.com.au](http://www.lgenergy.com.au)  
[www.lgenergy.co.nz](http://www.lgenergy.co.nz)

**STATE OFFICES**

**Queensland**  
Unit 4/105 Freight Street, Lytton,  
QLD, 4178

**South Australia**  
162 Richmond Road, Marleston,  
SA 5033

**New Zealand**  
600 Great South Road, Ellerslie,  
Auckland, New Zealand 1051

**Victoria**  
3 John Deere Court, Parkwest  
Estate, Derrimut, VIC 3026

**Western Australia**  
Unit 15/3 King Edward Road,  
Osborne Park, WA 6017

For further information or to find an Authorised LG Partner please see: [LGenergy.com.au](http://LGenergy.com.au)

